



# RULES WORKSHOP

Behavioral Health Support Specialist

# Presenters

---

**Nancy Delgado (DOH)**

*Program Manager*

**Melody Casiano (DOH)**

*Policy Analyst*

**Bill O'Connell (UW)**

*Clinical Training Program Director*

# Communication Avenues

---

- DOH Program Staff: [BHSS@doh.wa.gov](mailto:BHSS@doh.wa.gov)
- Sign up for [GovDelivery](#) for updates
- Check our [website](#)

## Other

- University of Washington [website](#)



# MEETING GUIDELINES

# MS Teams Features We Will Use Today

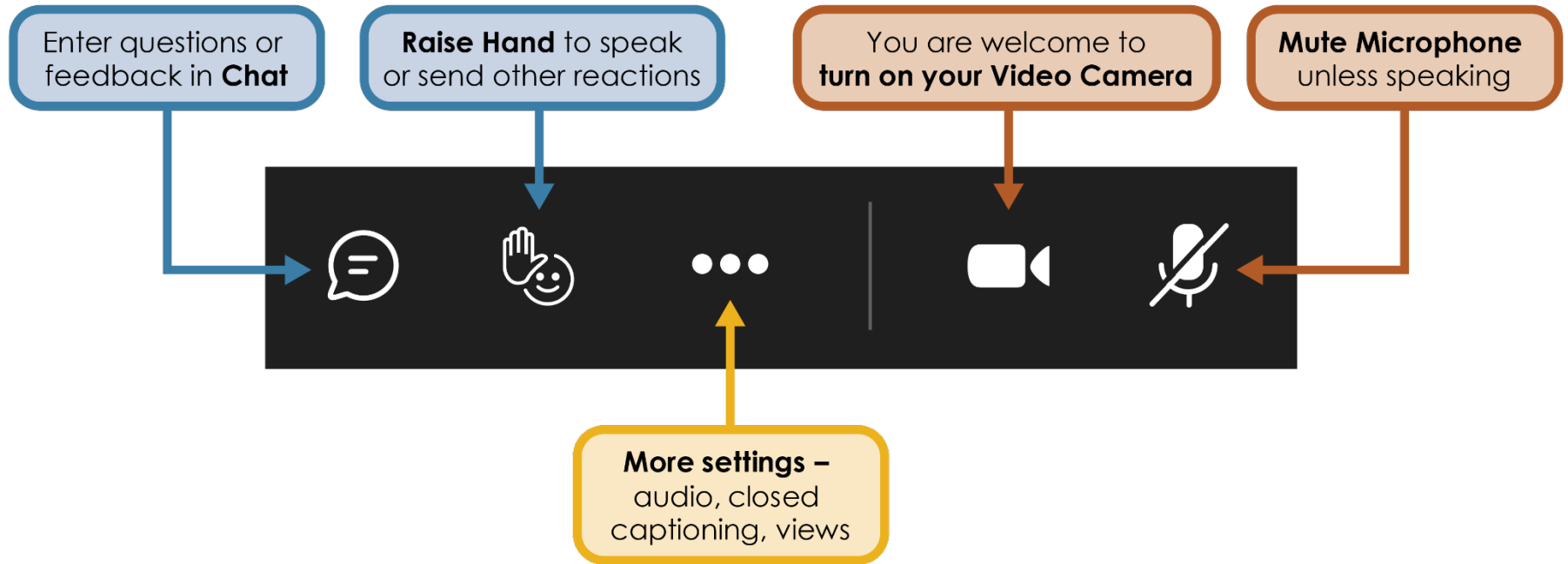

## Tips

- Try to be present
- State your name before speaking
- Speak clearly



# WORKSHOP OVERVIEW

# Agenda

---

1. Bill Overview
2. Background
3. Rulemaking Process Overview
4. Future Workshops

# Bill Overview

---

Substitute Senate Bill 5189 (2023) established a new profession: Behavioral Health Support Specialist (BHSS)

- Per the bill a BHSS is “a person certified to deliver brief, evidence-based interventions with a scope of practice that includes behavioral health under the supervision of a Washington state credentialed provider who has the ability to assess, diagnose, and treat identifiable mental and behavioral health conditions as part of their scope. A behavioral health support specialist does not have within their scope of practice the ability to make diagnoses but does track and monitor treatment response and outcomes using measurement-based care.”



continued...

---

- Must be implemented by January 1, 2025
- Establishing a profession requires:
  - Communication avenues (email, website, etc)
  - Rulemaking
  - Setting fees
  - Creating credentialing process and application packet
  - FAQs



BACKGROUND

# Behavioral Health Support Specialist

## Building Behavioral Health Education Pathways

University of Washington BHSS Clinical Training Program

Dr. Bill O'Connell, Program Director

Department of Health Meeting/ October 23, 2023

Email: [bhsswa@uw.edu](mailto:bhsswa@uw.edu)

# Why do we need a Behavioral Health Support Specialist?

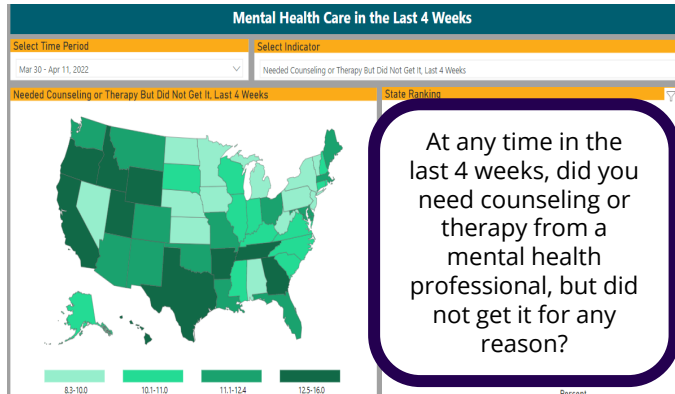

At any time in the last 4 weeks, did you need counseling or therapy from a mental health professional, but did not get it for any reason?

Many people in need

**Bachelor-level providers can rapidly expand the workforce**

Figure 1. Minimum Years of Typical Education and Supervised Experience Required for Select Behavioral Health Occupations in Washington State

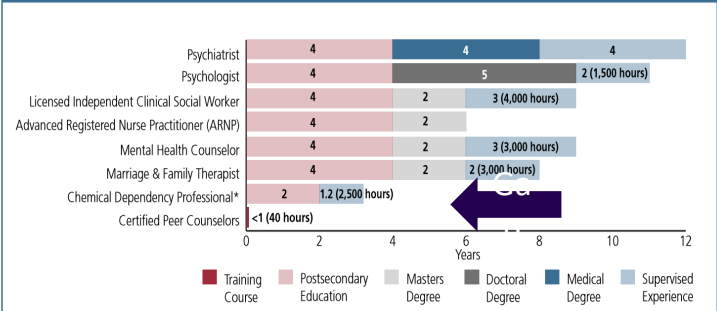

Currently takes many years to train new providers

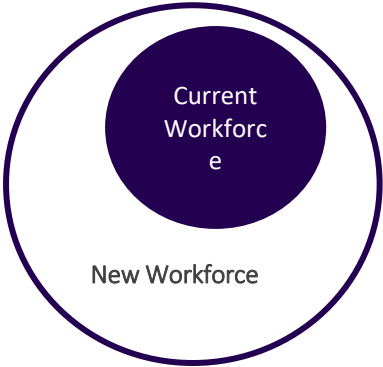

# PROPOSED SOLUTIONS

## Curriculum

### **Didactic curriculum:**

Provide content support for courses educational partners

### **Educational**

**Partners:** Continue to develop new partners

### **Skills Training:**

Continue to develop the ITS; Develop modified Anxiety Treatment Protocol

## Practice

### **Job Description:**

Develop job role details with partners

### **Clinics/Employers:**

Develop role and hiring support for early adopter clinics;

### **Practicum**

**Experiences:** Partner with new sites; Provide implementation support

## Policy

### **Licensure Requirements:**

Collaborate on rule making

**Payment and Billing:** Explore sources of revenue

# SOLUTION DEVELOPMENT

- **SSB 5189**
  - Established BHSS as a new WA provider type
- **UW Psychiatry & Behavioral Sciences**
  - Leading BHSS Clinical Training Program development
- **Higher Education Partners**
  - Deliver BHSS Curriculum
- **Behavioral Health Community Partners**
  - Host BHSS Practicum/Internships
- **Department of Health and Health Care Authority**
  - Oversee BHSS credential & modify State plan to include BHSS



# SOLUTION DEVELOPMENT

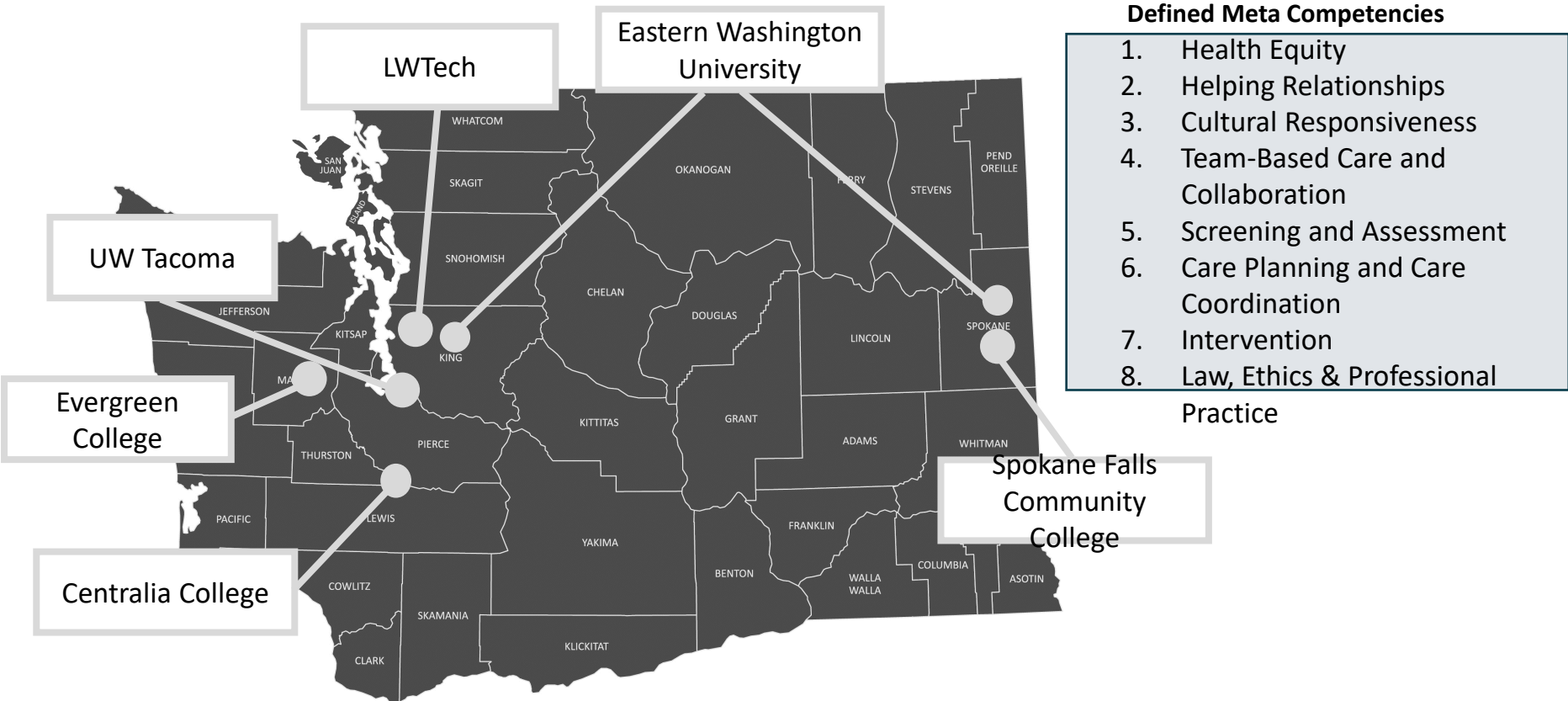

# VISION

**Goal:**  
**50 providers trained  
and 40 providers in  
practice by July  
2026**

Contact:  
[BHSSWA@uw.edu](mailto:BHSSWA@uw.edu)

Team Contacts: Bill  
O'Connell, Savannah  
Tidwell, Anna Ratzliff

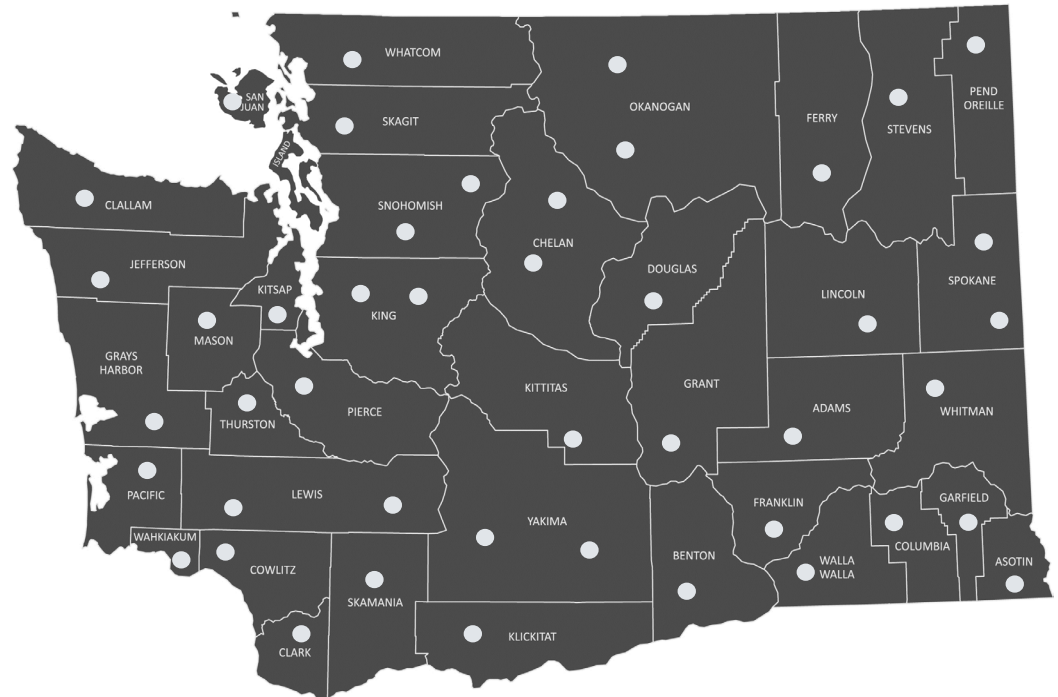





# RULEMAKING



## RULES OVERVIEW



# RULES OVERVIEW

# What is a Rule?

**Rule:** a regulation that helps give clarity if the underlying statute is broad or unclear

An enforceable directive that:

- Subjects a person to a penalty or sanction if that person violates a regulation
- Sets qualifications for conveying privileges to people or entities
- Sets procedures or practices for agency hearings
- Licenses or permits individuals or entities and revokes licenses or permits
- Sets project or material standards for goods before they can be sold or distributed in Washington

# Laws vs. Rules

Laws	Rules
Revised Code of Washington (RCW)	Washington Administrative Code (WAC)
Enacted by the Legislature and signed by the Governor	Rules must fit with the specific statutory authority
Serve as statutory authority or permission for our rules and activities	Used to implement laws and policies
Chapter 34.05 RCW is the law that tells agencies the process it must follow when adopting rules known as the Administrative Procedures Act (APA).	Title 246 WAC holds all Department of Health and State Board of Health rules and must comply with the APA.

# WAC Numbering System

## Example from the Pharmacy Quality Assurance Commission

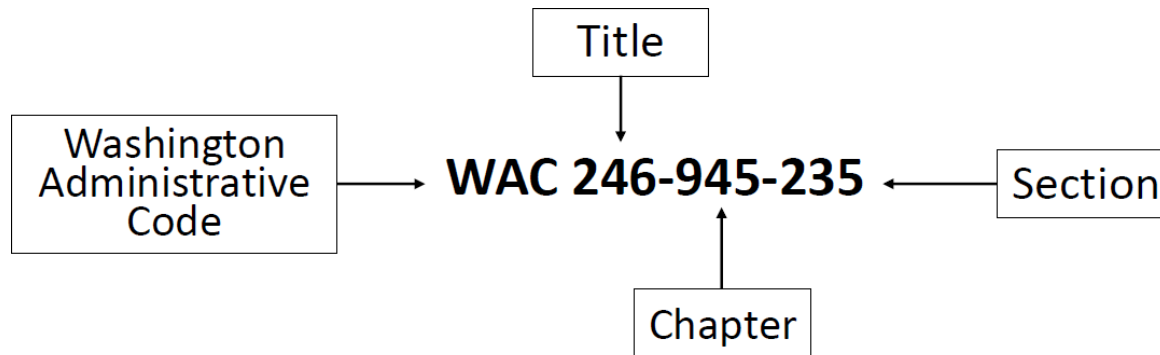

- **Title:** Each agency gets their own title number from the code reviser
  - Department of Health and State Board of Health → Title 246 WAC
- **Chapter:** Identifies subject matters regulated under agency’s statutes
  - Pharmacy Quality Assurance Commission → Chapter 246-945 WAC
- **Section:** Each section is considered an individual rule
  - “Nonresident pharmacy license” → WAC 246-945-235

# What May Generate Rulemaking?

- New or revised legislation
- Board/Commission or Department of Health (DOH) identifies need
- Formal petitions by interested parties under RCW 34.05.330
- Changes in technology or national standards
- Court decision
- Governor's directives



# STANDARD RULEMAKING PROCESS



# Standard Rulemaking Process

All phases include:

- Review and approval from DOH staff
- Filing with the Code Reviser (CR) office and issued a Washington State Register (WSR) number
  - Example: WSR 20-10-100
- Notification to interested parties

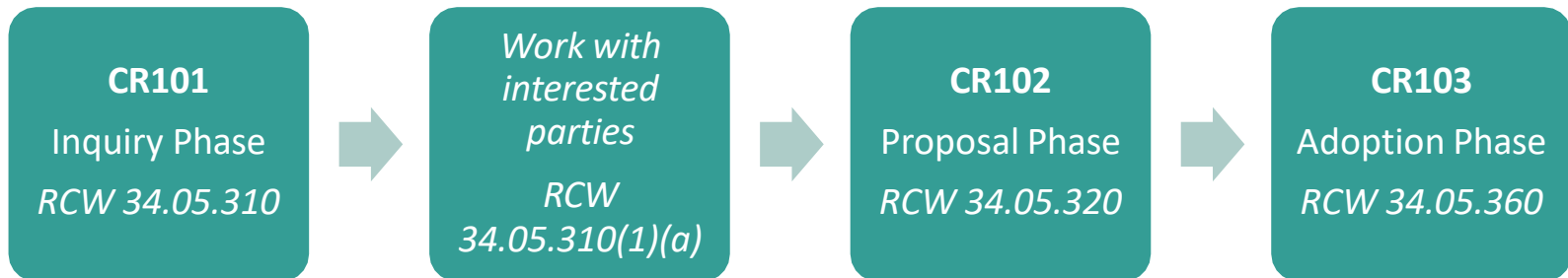

# Standard Rule Process\*

CR101	CR102	CR103
<ul style="list-style-type: none"><li>• Rulemaking is initiated</li></ul>	<ul style="list-style-type: none"><li>• Begin drafting rule language</li><li>• Determine potential costs</li><li>• Public meeting(s)</li><li>• Rules workshop(s)</li><li>• Written comment period</li><li>• Public Hearing (held at least 33 days after the CR102 filing)</li></ul>	<ul style="list-style-type: none"><li>• Rule language finalized</li><li>• Agency adopts rule (effective 31 days after CR103 filing)</li></ul>

\*Standard rulemaking may take 12 to 18 months to complete.



QUESTIONS?

# Approximate Timeline

---

File a new CR101 – completed July 2023

Rules workshops – Fall 2023 and Spring 2024

File CR102 – Summer 2024

Public Hearing – Fall 2024

File CR103 – November 2024

New BHSS credentials available – January 1, 2025



# RULES WORKSHOPS

# Topics of Discussion

---

- Definitions
- Education
- Supervisor requirements
- Continuing Education
- Practicum
- Jurisprudence Exam

# Dates and Topics

---

- October 25, 2023 - 12:00pm - (Education)
- October 25, 2023 - 5:30pm - (Education)
- October 30, 2023 - 1:00pm -  
(Practicum/Supervisors/Supervision)
- November 1, 2023 - 12:00pm -  
(Practicum/Supervisors/Supervision)
- November 1, 2023 - 5:30pm - (topic TBD)
- November 6, 2023 - 12:00pm (tentative)
- November 7, 2023 - 1:00pm (tentative)

Questions?

---



# Communication Avenues

---

- DOH Program Staff: [BHSS@doh.wa.gov](mailto:BHSS@doh.wa.gov)
- Sign up for [GovDelivery](#) for updates
- Check our [website](#)

## Other

- University of Washington [website](#)



To request this document in another format, call 1-800-525-0127. Deaf or hard of hearing customers, please call 711 (Washington Relay) or email [civil.rights@doh.wa.gov](mailto:civil.rights@doh.wa.gov).